

WM2 Positioning Systems

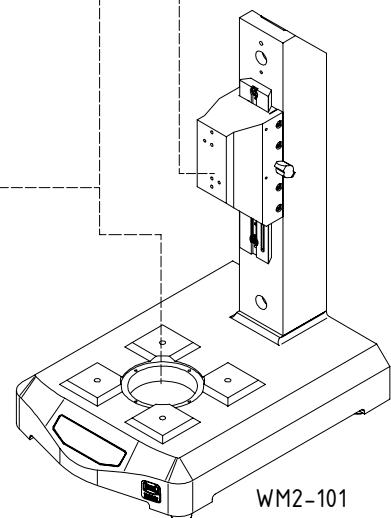
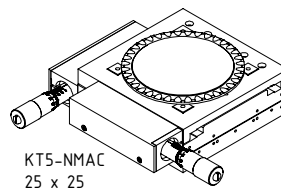
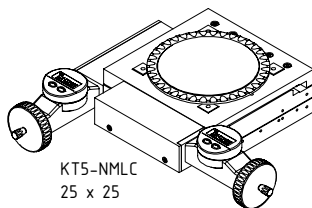
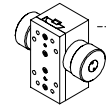
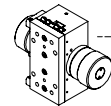
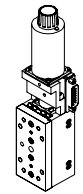
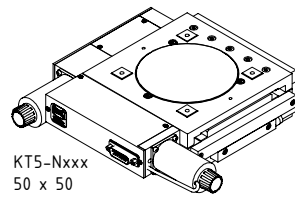
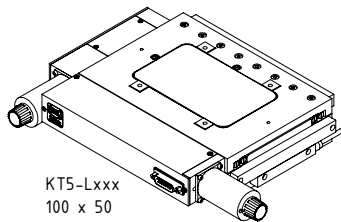
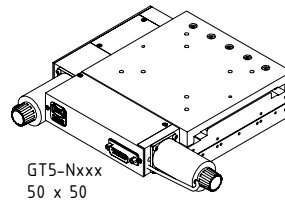
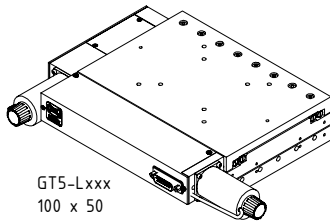
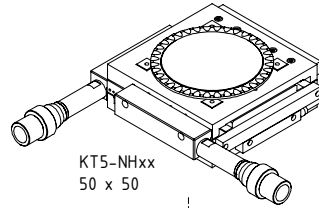
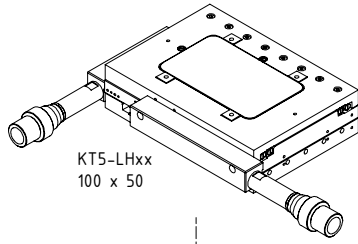

WM2-101:
Stable grey cast stand suitable for all stages of size 5.
The focus drives of the B40 series are additionally adjustable in height by a dovetail guide.